

The Parasitic Emission

Volume 39 • Number 1
January 2013

Supporting Amateur Radio Club Activities

In this 26-Page Issue...

On The Air	2
<i>A loving look back at the past year and some wild predictions...</i>	
Viewpoints	3
<i>Editorial and Opinion</i>	
Submission Guidelines	3
Hamshack Net on WAN-RS	4
600 Meter Bandpass Filter	22
<i>Tune in the excitement at 475 kHz, soon to be the newest ham band</i>	
Letters	24
<i>Probably the best newsletter I have ever seen.</i>	
Shorts	24
January 2013 Calendar	25
February 2013 Calendar	26
<i>Amateur Radio Club Activities, Events and Gatherings</i>	

Statistics:

13,458 words

59.5 hours editing

ISSN: 2156-0080



2013 – The Year of Inclusion

by Joe Shupienis W3BC

EVERY YEAR, editors everywhere seem to suffer an uncontrollable urge to take a loving look back at the past year, and to make wild predictions about the upcoming year. Your Editor does not wish to break with that tradition, so here goes...

2012 Top Ten Countdown

- 10 Club membership numbers are up, and members are more active.
- 9 There have been many club activities, casting Amateur Radio in a very favorable light in the public eye.
- 8 Clubs are working together and joining forces for activities such as Field Day and special events.
- 7 Participation in club activities has been steadily increasing.
- 6 Clubs are upgrading and building their own infrastructure, such as repeaters.
- 5 There is increased on the air activity in nets and contests
- 4 Meaningful Emergency Communications activities are being coordinated with Served Agencies, including drills and actual activations.
- 3 Licensing classes and Volunteer Exams are being conducted regularly.
- 2 **The “Year of Service” has been just that – a year of service!**
- 1 The world didn't end!

2012 was a great year for Amateur Radio, and for all of us Radio Amateurs as well. Great job everyone!

NOW IT'S TIME for me to make some of those wild predictions. One thing that stands out above everything else for me is the inescapable observation that all of the hams turning out for all of the many Amateur Radio activities genuinely seem to be having fun!

Another inescapable observation is that there are many hams who for one reason or another aren't sharing our happiness. Perhaps with a little effort on our part, we can spread the joy.

There are many ways we can include others—hams and non hams alike—in our Amateur Radio activities. We all have friends and we all have family—There's a great place to start. Let's bring them into our Amateur Radio circle and find ways they can enjoy our little hobby.

This concept has so much potential to bring so much good to Amateur Radio and our communities that it deserves to be the theme for this year: **2013—The Year of Inclusion.**

Ways to be Inclusive in 2013

- 1 Elmer a new ham. They need you and we all need them.
- 2 Reach out to other community groups. We all have something to offer to each other.
- 3 Volunteer a little of your time to help out at your club.
- 4 Befriend older hams—especially those who can't make it to activities as well as they once did
- 5 Prepare for emergencies. Is your “Go Kit” ready to go?
- 6 Bring a friend to your shack or your club.
- 7 Invite your family into your shack and include them in your ham activities

- 8 Make contact with inactive hams in your community and offer to help them experience today's ham radio
- 9 Invite non hams to Field Day, and give them the opportunity to get on the air with the GOTA station
- 10 Reach out to schools and other organizations by volunteering to give a presentation on Amateur Radio

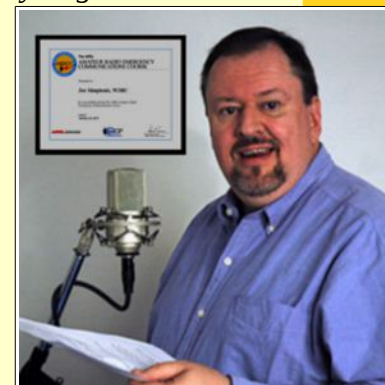

Each and every one of us is a “Goodwill Ambassador” for Amateur Radio, and often we are the only ham that someone knows. If we make a good impression and follow up with an invitation to them to “play radio” with us, we might just provide the incentive they need to start thinking about becoming a new ham!

But—whatever you do, don't use strong-arm tactics! Remember the wise old adage:

A man convinced against his will is of the same opinion, still.

It's far better to show them what we do, and let them make up their own minds than it is to try to force them into ham radio. If they see you enjoying yourself, it's only natural that they may eventually want to join in the fun.

You will find that people are much more easily persuaded by the gentle pull of **attraction** than they are by the ear-splitting drum-beat of **promotion**.

It's 2013, The Year of Inclusion. Let's all make sure we include everyone we can in our one, big, happy, ham radio family! Happy New Year!

I'll see you... **On The Air!**

A loving look back at the past year and some wild predictions...

The Parasitic Emission

January 2013

Submission Guidelines

by Joe Shupienis W3BC, Editor

EVERY MONTH, the *Club Connections* section highlights the activities and provides (hopefully) up to date contact information for each participating club.

The most time-consuming part of assembling each issue has been obtaining and formatting the clubs' information each month. While most clubs have done a great job of keeping their information current, a few have sent no updates in over a year.

This newsletter is read by prospective hams and others interested in Amateur Radio in your community. It's very important for them to be able to contact your club officers, find your current website, and find out when and where your next club meeting will take place.

Only having out of date information forces a decision between two bad choices: **Is it better to omit wrong information or to include it anyway and hope for the best?**

After much thought, and recognizing the responsibility to provide accurate information to every reader of this publication, the following policy is in effect immediately:

To be fair to all readers, the club pages will be omitted for those clubs that have not submitted current club information by the deadline each month.

All current subscribers will continue to receive *The Parasitic Emission* until they request to be removed from the distribution list, regardless of any club affiliation.

This will help ensure that *submitted* material will be published on schedule.

Publication Deadline

Please submit all information for publication in the next month's edition no later than the 4th Monday of each month. Please note: The 4th Monday is NOT always the "last" Monday.

Publication Date	Deadline
February 2013	Monday, January 28
March 2013	Monday, February 25
April 2013	Monday, March 25
May 2013	Monday, April 22

Please submit large articles, items containing multiple submissions from the same group, multiple photos, or material (text and photos) that will require significant editing earlier than the deadline.

Text Specifications

Plain text that is ready to cut and paste into the publication is preferred if it is possible for you to do so. You may use a word processor or Notepad. You can even type the article into an email.

We might not be able to process or decipher Microsoft® Publisher™ or Works™ documents. Please use something else!

Photo Specifications

In this age of digital cameras and email, it's pretty easy to submit photos. Professionals attach **one** photo to an individual email, the subject is the name of the article the photo goes with, and the text of the message is the caption of the photo, followed by the names of recognizable people in the photo. Please keep captions short and on topic.

How to Submit

Please send all material by email to:

submit@parasiticemission.com Meeting

Legal Notices

The Parasitic Emission (ISSN: 2156-0080) is published monthly by **Joe Shupienis, 96 Third Street, Falls Creek, PA 15840**

All original content is the property of its authors. Their contributions are gratefully acknowledged. **All opinions expressed are those of their authors only.**

The design, format, and presentation of this publication, and all material not attributed to other authors is

Copyright © 1975, 2009-2013
Joe Shupienis, W3BC
All Rights Reserved

Quedan reservados todos los derechos

Reproduction or republication by any means, in whole or in part, is prohibited by law without prior written permission and attribution of the Author(s).

The Parasitic Emission is published monthly for all Radio Amateurs residing in central Pennsylvania. This electronic edition is provided free of charge by email, and may also be downloaded from:
www.parasiticemission.com
which also makes available selected back issues, current issues and more.

— . . . —

The current, online, interactive version of the calendar, which contains regional club activities and events in upcoming months may be accessed at

calendar.parasiticemission.com.

You may use that calendar to enter amateur radio events of interest to local amateurs which are intended for publication, subject to review and approval.

Happenings and news from and about our readers

The Parasitic Emission
January 2013

The Quad-County Amateur Radio Club

An ARRL Special Service Club Serving Clearfield, Jefferson Elk And Cameron Counties Since 1975

seconded by KA3USM, the October Treasurer's report was **Approved** as read.

Activity Coordinator KB3WBT reported on

Quad-County ARC Information

President	H. Deforest Murray, III W3TM <i>president@qcarc.org</i>
Vice President	Louis "Peach" Caltagarone AB3OG <i>vp@qcarc.org</i>
Secretary	Joe Shupienis W3BC <i>secretary@qcarc.org</i>
Treasurer	Doug Rowles W3DWR <i>treasurer@qcarc.org</i>
Executive Board	Bev Hudsick W3BEV Don Jewell KB3LES Lars Kvant KB3WBT Sam Mc Ghee KA3USM Bryan Simanic WA3UFN
Staff	Activities: Lars Kvant KB3WBT Education: Joe Shupienis W3BC Membership: Doug Rowles W3DWR Net Manager: Doug Rowles W3DWR Liaison, ARC: Greg Donahue KB3WKD Liaison, BSA: Peach Caltagarone AB3OG Program Coordinator: Joe Shupienis W3BC Public Information: Joe Shupienis W3BC Public Service: Kevin Snyder KA3YCB QSL Manager: Al Maddas KB3SVW Technology: Lars Kvant KB3WBT/SM7FYW Trustee: Bryan Simanic WA3UFN VE Liaison: Bryan Simanic WA3UFN
Repeaters	N3QC 147.315+ [173.8]Rockton Mt KE3DR 147.390+ [173.8]Rockton Mt N3NWC 443.475+ [173.8]Rockton Mt K3EDD 444.625+ [173.8]Rockton Mt N3IZE 444.900+ [173.8]Clfd local KG4ZXC 145.350- [173.8]Chestnut Gr N3QC-1 144.390 APRS Digipeater
Nets	Sunday @1900 147.315 Quad-County FM Net Wednesday@1900 147.315 Hamshack Net
Web	www.qcarc.org , info@qcarc.org @qcarc

Minutes: December 2012

by Joe Shupienis W3BC, Secretary

THE DECEMBER 2012 meeting was not convened because the Penn State DuBois Campus closed early due to severe weather and winter storm warnings.

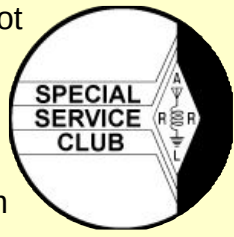

Minutes: November 2012

THE MEETING was called to order by President W3TM at 7:30 pm with a salute to the Flag, followed by a moment of silence in memory of Silent Keys. Introductions were made for all present.

Attendance

W3BC, WB3OG, KB3WKD, KB3LES, W3TM, W3DWR, KA3FHV, K3EDD, AB3RB, KB3ZBJ, W3BEV, and visitor Steve KB3FPN.

Staff Reports

Secretary W3BC read the minutes of the October Annual Meeting. On a motion by KB3LES, seconded by KA3FHV, the Minutes were corrected to include all members nominated for the office of President, and were then **Approved** as corrected. There was no correspondence received or sent.

Treasurer: W3DWR reported the treasury stands at \$340.14, with a total membership of 54. He indicated that 2013 dues are now due and payable. On a motion by W3TM,

Meeting Notice

by Joe Shupienis W3BC, Secretary

OUR NEXT MEETING will be Friday, January 18th at 7:30 pm. The meeting room is in the Hiller Building on the Penn State DuBois Campus.



On the agenda: Activity plans including our assisting the PAARC with their Groundhog Day special event station on Feb 2nd, and setting up an amateur radio demonstration station at Camp Mountain Run for the annual Cub Scout Klondike Derby activity, Feb 9th.



Following the meeting there will be a program featuring hands-on training in digital communications using NBEMS to easily set up any radio and computer.

Hamshack Net on WAN-RS

by Joe Shupienis W3BC

STARTING IN January, the Hamshack Net will meet on the Wide Area Network Repeater System. We are testing the possibility of serving more hams in a larger area. Check in on Wednesdays at 1900 on any WAN repeater, or by Echolink!

activities planned for 2013. W3DWR reminded everyone about the Christmas Dinner on Saturday, December 15. W3BC gave a report on the CQ WW DX contest effort that took place at Hummingbird Speedway on October 26-28, and publically thanked Peach AB3OG for inviting the club to use his hilltop cabin at the racetrack. Punxsutawney Area Amateur Radio Club President KB3FPN advised that the date for that club's Groundhog Day special event would be on February 2nd this year, and invited members to stop by the PAARC hamshack at the Punxsutawney Airport.

Education Coordinator W3BC reported that three new and upgraded licensees passed their exams at the October VE session, and introduced new hams AB3RB and KB3ZBJ. He is looking for suggestions for communities for the spring classes to begin in February or March.

Net Manager W3DWR reported that the Sunday Evening Quad-County 2 meter net is going strong. He also reported that the Wednesday evening Hamshack Net has good discussions each week and hopes more hams will check in. Hamshack NCS will be Jeff KA3FHC for the month of December.

Program Coordinator W3BC asked for suggestions for programs members would like to see, and reported he is "beating the bushes" to find interesting speakers.

Public Service Red Cross Liaison KB3WKD reported that the Red Cross would like to discuss further participation with QCARC, perhaps with another SET-like drill in the spring, to include northern counties that both organizations cover.

Scouting Assistant Liaison AB3OG reported that he has been in contact with the

Bucktail Council to make arrangements to set up another demonstration at Camp Mountain Run in February.

Public Information Officer W3BC reported that he will contact the Jeff Tech administration to make arrangements to present a program on Amateur Radio to the students in the Protective Services program.

Old Business

W3BC reopened the topic of the club hosting a hamfest. General discussion followed but no motions were made.

W3BC asked if several volunteers could meet at Ed Golla's QTH to return the very heavy picnic table to its original position as we promised K3AHS that we would. KB3LES, W3TM, AB3RB and W3BC agreed to move the table the following Sunday at 2:00 pm.

New Business

President W3TM asked for nominations for several Staff appointments. W3BC nominated W3DWR to be the Membership Coordinator, second by KA3FHV. **Appointed by vote.**

W3BC nominated and W3TM seconded AB3OG as Scouting Liaison. **Appointed by vote.**

W3BC nominated KA3WBT, WA3UFN and KB3LES to the Constitution committee. W3TM nominated W3BC. W3DWR seconded all nominations. **Appointed by vote.**

W3TM nominated W3BC for Program Coordinator, seconded by KA3FHV. **Appointed by vote.**

The position of QSL manager is currently held by KB3SVW, who has been having

health issues. It was suggested that we contact Al and see if he wishes to continue.

W3BC moved, and KB3LES seconded to table the appointment of a Hamfest Committee until the December meeting. **Tabled.**

There being no further business, W3BC moved and KA3FHV seconded to adjourn the meeting. **Adjourned** at 8:25.

Refreshments were served by W3BEV, and a general discussion/social hour followed.

Respectfully submitted,
Joe Shupienis W3BC, Secretary



Minutes - October 2012

By Herb Murray W3TM, Secretary

THE ANNUAL MEETING was called to order by President Shupienis at 7:30 pm with a salute to the Flag, followed by a moment of silence in memory of Silent Keys. **Introductions** were made for all present.

Attendance

W3DWR, KA3FHV, KB3WBT, KB3VWX, N3WWT, KA3USM, W3TM, N3DIR, AB3OG, W3BC, W3BEV, Roger McEachron.

Speedway facilities in support of our group effort.

W3BC encouraged all stations planning to participate in the November Sweepstakes to be sure to list their club affiliation as Quad County Amateur Radio Club, to add to the club's aggregate score.

Education & Training Coordinator W3BC reports licensing classes are progressing in DuBois, with 3 students nearly ready for the VE tests to be held on October 25th.

Net Manager W3DWR reports all is going smoothly. W3TM asked for a volunteer for the November sessions of the Hamshack Net.



In **Public Service**, W3BC and Red Cross Liaison KB3WKD reported on operations during the **SET** on October 3rd. Six members participated and set up communications between Red Cross shelters in Brookville and Big Run, Red Cross HQ in DuBois and the Jefferson County EOC. Jefferson County EC KA3YCB forwarded his remarks that he was "elated" at the response and that Amateur Radio made a good showing to Public Safety officials participating in the drill.

AB3OG stated that he contacted the **BSA** Bucktail Council regarding the 2013 Klondike Derby, and the sponsors

September Meeting. On a motion by KA3FHV, seconded by KA3USM, the Minutes were **Approved** as read. There was no correspondence received or sent.

Treasurer W3DWR reported that the Clearfield County Fair Board returned our deposit for last year's Field Day site rental, and that we have paid the deposit for FD 2013. On a motion by W3TM, seconded by KA3USM, the October Treasurer's report was **approved** as read by Treasurer W3DWR.

Committee reports

Activity coordinator KB3WBT discussed club participation in the Boy Scouts Jamboree on the Air. We are not able to participate in a meaningful way this year, but the members expressed their intentions to prepare for and participate in 2013.

W3BC reported that the Fall Picnic was held at Ed Golla's QTH on September 29th and was a big success. 16 Members and guests took part and enjoyed another day of ham radio fun and friendship at the scene of so many club events that have been taking place there since the very beginning of the club in the 1970s.

The club will take part in the CQ WW DX contest as a Multi-2 entrant. AB3OG has offered the use of his Hummingbird



Club Technology Coordinator KB3WBT discusses radio with new ham Roger, as KA3FHV and W3DWR look on

Annual Meeting - Annual Reports

This being the **Annual Meeting**, the **Presentation of Annual Reports** was made, beginning with the **Roll Call of Executive Board** members. All Board Members were present with the absence of WA3UFN (at work), W3PIG and KB3LES (family commitment).

President W3BC presented the **Annual Activity Report** as a photo exhibit summarizing the Club's activities throughout the preceding 12 months. [The report is available as a PDF file on the Club's website.](#)

Treasurer W3DWR gave the **Annual Financial Report** and the **Annual Membership Report** for the preceding 12 months.

On a motion by W3TM, seconded by KB3VWX, the annual reports were **Approved**.

The members **officially recognized** the Officers and Staff, and thanked them for their outstanding service and direction during the past year, with a hearty round of applause.

Secretary & Treasurer Reports

Following the conclusion of the Annual Reports, at the request of the **Secretary**, the President read the minutes of the

enthusiastically invited us to participate again in February 2013.

Public Information Officer W3BC reports that QCARC is now on Facebook, after resolving the issue with another party using our name.

Old Business

W3DWR reported the Holiday Dinner will go ahead as planned on Saturday, December 15th, 6:30 pm at the Arrowhead Restaurant, Route US-322, East of Clearfield. On the menu: Buffet with Ham and Turkey, Stuffing, Mashed Potatoes and Salad.

New Business

KB3WBT proposed the Club sponsor a hamfest. Discussion followed regarding the offers from Super 322 Drive-In and from Hummingbird Speedway to use their facilities for the hamfest. **Moved by KA3USM and seconded by KB3WBT and AB3OG to proceed.** Motion passed.

AB3OG reported he is on the Occupational Advisory Committee for the Protective Services program at Jeff Tech, and that he has discussed Amateur Radio with the instructor, who is "very interested." **Moved by W3DWR and seconded by KA3USM**



KA3FHV and W3DWR count the ballots

to contact Jeff Tech to set up a presentation. Motion passed.

KA3USM moved and KB3WBT seconded to add a UHF link to the 147.315 repeater to provide enhanced services. Motion passed.

KB3WBT moved and KA3USM seconded that the club obtain and install VHF and UHF beacons at the Rockton Mountain Site. After discussion, motion passed.

Annual Meeting - Election of 2013 Officers

There being no further regular club business, the Annual Meeting resumed with nomination and election of officers.

KB3WBT and KB3LES nominated W3TM for President. W3BC expressed his wishes not to be President for 2013 and turned the gavel over to Vice President N3DIR for the duration of the balloting. W3TM and KB3LES nominated KB3WBT for President. KB3WBT nominated AB3OG for President. Nominations for President were closed, and balloting took place. The members elected W3TM President.

AB3OG was the only candidate for Vice President, and was elected by acclamation.

W3BC was nominated for Secretary by KA3FHV, and was elected by acclamation.

W3DWR was the only candidate for Treasurer, and was elected by acclamation.

Executive Board: Nominations from the September meeting included KB3LES, KA3USM and N3WWT. The following were then nominated: KA3FHV, KB3WBT, WA3UFN and W3BEV.

The votes were tallied, and elected to the Executive Board were: KB3LES, KB3WBT, KA3USM, WA3UFN and W3BEV.

After the balloting, W3BC returned to the

chair, and thanked the members for their service during the past year. In his final act as President, W3BC administered the oath of office to the newly elected officers, and passed the gavel to incoming President W3TM.

On a motion by KA3USM, the meeting was adjourned at 9:35 pm for refreshments and a show and tell program on vintage radios.

Respectfully submitted,
Herb Murray W3TM, Secretary



Minutes - September 2012

by Herb Murray W3TM, Secretary

THE REGULAR September meeting of the Quad-County Amateur Radio Club was called to order at 7:30 pm, Friday, September 21, 2012 by President Joe Shupienis, W3BC.

Attendance

16 members and one guest were in attendance: W3BC, KA3FHV, W3YOZ, KB3YJH, KB3YJG, KB3LES, KB3WKD, KA3USM, N3NWT, AB3OG, W3DWR, W3TM, Roger McEachron, Thomas Shute, and Paul Murphy. Guest was "Annie" who didn't have much to say.

Secretary

The Minutes of the August meeting were read by Secretary W3TM. On a motion by KA3USM, second by AB3OG, the minutes were **approved** as read.

Secretary W3TM reported that no correspondence was sent or received.



Treasurer

W3DWR reported the Club treasury balance stands at \$518.63. On a motion by KB3LES, second by KA3USM, the Treasurer's report was **approved** as read.

Membership stands at 52 members. Treasurer W3DWR reports that this is the first the membership has been over 50 in a long time.

Committee Reports

Activity – Plans for the Fall Picnic at Golla's are finalized for Saturday, September 29th, rain or shine. Members of the Punxsutawney Area Amateur Radio Club are invited to attend.

Plans for the Christmas Party on December 15 at the Arrowhead Restaurant are proceeding.

Education & Training – Joe reported that there are 3 attending the class and a VE

exam session is scheduled for October 25.

Nets – Doug reported that the Quad-County 2 Meter Net is still enjoying good participation., A volunteer to be NCS is needed for the Hamshack Net for October. In the absence of volunteers, W3TM volunteered to continue for the month.

Programs – Tonight, AB3OG will provide a hands-on orientation to CPR and AED lifesaving. Next month will be Boat Anchor night.

PIO – W3BC reports that press releases for the Baker Trail event as well as Race Day and the Super 322 Car Show have been submitted to various media but not picked up.

Public Service – Kevin Snyder forwarded a report on the Baker Trail event, and information on the October 6th SET.

Community Outreach – AB3OG volunteered to contact the BSA Council regarding JOTA to be held October 20-21.

Old Business

There was no old or unfinished business

New Business

There was no new business

Annual Elections – Nominations

Nominations for all club offices were opened as required by the Constitution. The following nominations were made:

- W3BC for President by KB3LES
- AB3OG for Vice President by W3BC
- W3TM for Secretary by KA3FHV
- W3DWR for Treasurer by KB3LES
- KB3LES for Executive Board (Jefferson Co) by W3DWR

KA3USM for Executive Board (Clearfield Co) by W3TM

N3WWT for Executive Board (Clearfield Co) by KA3USM

Nominations will remain open until the election at the Annual Meeting to be held October 19, 2012.

With no further business to be brought before the Club, on a motion by KA3USM, second by KA3FHV, the meeting was adjourned at 8:15 pm.

Following the meeting, refreshments were served and Peach AB3OG presented a hands-on demonstration of CPR techniques.



Minutes: August 2012

by Herb Murray W3TM, Secretary

THE REGULAR August meeting of the Quad-County Amateur Radii Club was called to order at 7:30 pm, Friday, August 17, 2012 by President W3BC. Following the Salute to the Flag, a moment of silence in remembrance of Silent Keys was observed.

Attendance

10 Members and guests were in attendance: W3BC, N3WWT, KA3USM, AB3OG, W3BEV, KB3LES, KB3WBT, KA3FHV, W3DWR and Roger McEachron.

Reports

On a motion by KB3LES, seconded by KB3WBT, the minutes of the July meeting were **approved** as published in *The Parasitic Emission*. No correspondence was received or sent.

The Treasurer reported that the balance in the treasury is \$512.73. Membership stands at 51 members. On a motion by KA3FHV, seconded by KB3WBT the treasurer's report was **accepted** as read.

Staff reports

Reports of club **activities** were given by the participants. The Race Day at Hummingbird Speedway was a success, and track manager Peach Caltagarone has invited us back next year. The Car Show at the Super 322 Drive-In was well received by the participants and the drive-in owners who invited us back next year.



Upcoming activities: KA3YCB sent a report to W3BC on communications support for the Baker Trail Ultra Challenge to be held Saturday, August 25. Ed Golla K3AHS has invited us to hold another picnic at his

father's QTH south of Reynoldsville on Saturday August 29th. W3DWR reports that the new owners of the Arrowhead Restaurant will honor our Christmas Party reservation for Saturday, December 15. W3BC reported that licensing classes will begin Thursday, September 13 in DuBois. A VE session is scheduled for 6 pm, Thursday, October 25, at the Red Cross office in downtown DuBois.

W3TM volunteered to be NCS for the Hamshack net for September.

Upcoming programs include CPR in September, Vintage radios in October or November.

Public Service: KA3YCB sent a request that we make a list of those planning to participate in the Baker Trail event. The ARRL SET is October 6, and we will be participating with the PA Heartland Red Cross Chapter. KB3LES and KA3USM volunteered to help out.

Old Business

W3DWR moved to remove from the table a motion to change our breakfast location to the Arrowhead Restaurant. Motion was brought off the table, W3DWR called the question and a vote was taken. The original motion to hold future breakfast meetings at the Arrowhead Restaurant in Clearfield,



carried.

New Business

On a motion by W3DWR, seconded by W3BC, the club extended Honorary Membership to Marty Johnson W3YOZ for his continued support and participation in the club, traveling all the way from the Annapolis, Maryland area. Motion **carried unanimously**.

On a motion by KA3USM, seconded by KB3LES, meeting **adjourned** at 8:35 pm, followed by refreshments courtesy of W3BEV, and a program showcasing our Amateur Radio Homebrew projects.



Meeting Notice

August 14, 2012

June Meeting

THE AUGUST MEETING of the Punxsutawney Area Amateur Radio club will be held Tuesday,

August 14 at 7:00 pm at the Punxsutawney Presbyterian Church, Findlay Street in downtown Punxsutawney. Refreshments will be served after the meeting.



Special Event Station for Groundhog Day

GROUNDHOG DAY falls on Saturday this year, so the special event will be held on February 2nd at the Punxsutawney Airport.

1400Z-2100Z (9 am – 4 pm), 14.330, 7.138 and 3.845 MHz. Also on the WAN Repeater System. Certificate by QSL to Punxsutawney Area Amateur Radio Club, PO Box 3, Punxsutawney, PA 15767. www.punxclub.com



Monthly Breakfast

EVERY MONTH, the Punxsutawney Area Amateur Radio Club gets together with our friends for a friendly club breakfast at the "Amish Restaurant" along route 310 between Punxsutawney and Reynoldsville. The food is great, the price is very reasonable and the service is outstanding.

If you've never been there, why not stop in? The address is:

Betsy & Clara's Amish Bakery
2147 Route 310
Reynoldsville, PA 15851

This month's breakfast will be at 10:00 am, Saturday August 25th. See you there!



The Punxsutawney Area Amateur Radio Club

Serving Punxsutawney and Jefferson County



PAARC Information

President	Steve Waltman KB3FPN
Vice President	Don Jewell KB3LES
Secretary	Peach Caltagerone AB3OG
Treasurer	Tom Sprague KB3TOY
Nets	Monday @ 1930 147.390
Web	http://www.punxclub.com

10 Club connections

The Parasitic Emission

January 2013

The Headwaters Amateur Radio Club

Serving Coudersport and Potter County

will be open for more nominations before voting at the December meeting.

Several members explained Amateur radio and discussed the fun in Amateur radio to the guests.

Mike and Tom Perry donated a code practice oscillator to the club for members to borrow. Linda and Glenn borrowed the oscillator for now.

Mike made a motion to have an associate membership for social members at a reduced rate. And to give new licenses a free year membership. Running from Jan1 – Dec 31. Glenn seconded.

Motion to adjourn by Glenn at 8:43 Linda seconded.

Attending were. Wayne, Jim D, Jason, Bill, Tom, Jim L, Adrian, Tom Perry, Mike, Jim C, Diana, Milton, Glenn, Linda.

Headwaters ARC Information	
President	Jim Douglas K3FHC
Vice President	Jason Layton K2BYL
Secretary	Tom Guilfooy WA3HLC
Treasurer	Wayne Stahler, II, WS3PC
Repeaters	N3PC 146.685- [173.8] Couderspt N3PC 443.300+ [131.8] Galeton K3CC 146.880- -OPEN- Couderspt KB3EAR 444.300+ Couderspt
Nets	Monday @ 1900 146.685- [173.8] Monday @ 1930 28.360 [USB] Monday @ 1945 1.980 [USB]
Web	www.n3pc.com

Jim D talked about the falling leaves festival, The club is welcome back in the spring.

Tom talked about the noise level and poor band condition at the falling leaves festival. He suggested if we do it again to try and setup away from the road to try and get



away from some background noise. We had live video going from the special event station for awhile, Something to think about and do more at another special event.

Jim D talked to the DCNR about the dog sled race. Not much information was available. DCNR stated we could not drive into the area which could be a problem with the weather and communications.

Linda suggested we contact the dog sled club and possible attend a meeting to learn more.

Tom talked about the repeater being down for a short time in the beginning of hurricane Sandy due to a generator not starting. Tom also talked about adding a battery backup for the repeater.

Jason suggested we use the output of the repeater if it's down. Hopefully it will not go down in an emergency again.

Glenn talked about and gave a demo on flashlights, Head lamps and portable lighting.

Nominations for President were Mike N2COD, Vice president Jim D, Jason. Treasure Wayne. Secretary Tom. The floor

Meeting Notice

THE JANUARY meeting of the Headwaters Amateur Radio club will be held Thursday, January 3 at 7:00 pm in the Conference Room at the Charles Cole Memorial Hospital. Park near the helipad and use entrance "A."

Following the meeting we meet for an evening snack at McDonald's Restaurant in downtown Coudersport.

November Minutes

November 1, 2012

JIM D called the meeting to order at 7:00PM.

Minutes from October meeting were read. Motion to accept by Wayne, Jim L 2nd.

Treasure Report

Balance \$528.73

Income Dues \$85

Balance forward \$613.73

Motion to pay 2 bills. One to Greg for supplies for special event, One to WPA repeater counsel. Motion by Glenn to pay seconded by Don.

Several guests attended the meeting KA2KGP Tom, (Mikes brother), Frank, Rick.

New Business

October Minutes

October 4, 2012

JIM CALLED the meeting to order at 7:00PM.

September minutes were read. Glenn motioned to accept Wayne seconded.

Wayne read the treasure report.

Treasure report

Balance \$528.73

Outgoing \$ 0

Incoming \$ 0

Balance \$528.73

Jim L motioned to accept Glenn seconded.

New Business

Jim D talked about the Falling Leaves festival and the special event station. We have space #21 and will setup around 8:00 AM. We have a lot of literature and handouts from the ARRL and the EOC.

Tom suggested we take some 3X5 cards so people could fill them out if there interested in a class this year.

Mike talked about morse code. He passed out a list of morse code study material he made.

Jason talked about the Monday evening net and that he is having antenna problems if anyone could run the net for awhile.

Tonia talked about an email a sled dog group sent us asking if the club could possibly help with communications during there event on January 12 & 13th 2013. It was suggested we contact them and see if they could possibly meet us at the special

event station and talk to us more and see what the club was all about.

Jim C stated the meeting room at the Charles Cole Memorial is still available for us to use.

Glenn motioned to raise family dues to \$20.00 and individual to \$15.00. Mike seconded motion passed.

Jim D talked about the PA QSO party and if anyone was interested. Linda said the EOC is available for us to use.

Tom reminded everyone nominations for club officers will be at the next meeting.

Jim C motioned to adjourn, Wayne seconded.

Meeting adjourned at 8:05 PM.

Attending were, Jim D, Jim C, Tonia, Tom, Diana, Jim L, Glenn, Linda, Mike, Milton, Wayne, Jason.

September Minutes

September 6, 2012

M EETING WAS called to order @ 7:00 PM by Jim Douglas.

Minutes from August meeting were read. Wayne motioned to accept, Jim L seconded.

Wayne read the treasure report

Treasure Report

Balance \$493.73

2013 Dues Jim Douglas \$15.00

K2BYL donation \$20.00

Balance forward \$528.73

Jim C motioned to accept, Glenn seconded.

New Business

Jim C will contact the Charles Cole Memorial Hospital about continuing to use the meeting room.

Glenn mentioned the Battery Warehouse will give club members a discount.

Glenn discussed the bad circuit board on the transfer switch at Crandall Hill site and it had been replaced and tested.

Don did a talk and passed samples around about cables from audio to feed line to fiber optics. He talked about early TV, Antenna's, VHS tapes, Resolution, etc.

Glenn did a talk and demo about Anderson Power Poles, The proper way to install them and all the accessories available. More information is available at www.powerwerx.com/assembly.asp

Jim D suggested we all learn CW. A little at a time helps maybe some each meeting.

We discussed the up coming PA QSO Party and possible having it at the EOC. More at the next meeting.

Greg discussed the falling leaves special event station Friday & Saturday Oct 5th & 6th.

The November meeting we will have nominations for club officers and the December meeting vote for officers.

Meeting Adjourned at 8:45 PM

Attending were Jim D, Jim C, Tonia, Tom, Diana, Jim L, Glenn, Linda, Don, Mike, Adrian, Wayne, Milton.

August Minutes

August 2, 2012

JIM DOUGLAS called the meeting to order at 7:00PM

Minutes from July meeting were read. Wayne Motioned to accept, Adrian seconded

Treasure report by Wayne

Balance forward	\$498.73
Donations	\$70.00
Field Day Check	-\$75.00
Balance	\$493.73

Glenn motioned to accept treasure report, Diana seconded.

Jim C passed around a nice Certificate for the Potter County Marathon support.

Jim C commented on field day and possible holding an event on the town square.

Tom talked about the repeater being down during the storm for a short time, He drove up to the repeater site and discovered the generator was running and the transfer switch had a problem. He notified the County EOC and they had the problem resolved shortly.

Glenn did a very informative talk about batteries with loads of equipment to pass around. You can find the information on our web site at WWW.N3PC.COM under meeting presentations. Glenn mentioned he has had very good luck using Sanyo ENELOOP size AA rechargeable battery's.

Glenn will do a future talk about power systems.

Jason talked about the Monday nite net and

if nobody starts the net please feel free to run the net.

Tom will try and bring DVD's about Arc Fault breakers and Arc flash safety to the next meeting.

Jason commented how nice and informative the Disc was that Glenn passed out at the July meeting.

Tom talked about the recent 13 colonies special event station held during the 4th of

July weekend and passed around some nice QSL cards and certificate he and Diana received.

Remember to check our web page from time to time for additions, Announcements, ETC.

Meeting adjourned at 8:30PM

Attending were. Wayne, Jim H, Adrian, Glenn, Linda, Mike, Milton, Don, Jim L, Jason, Diana, Tom, Jim C, Jim D.



Elk County Amateur Radio Association

Serving Elk and Cameron Counties

have much time to alert the members.

Now, we'll do some testing and see if we made progress with the repeater.

73,
Pete WW3O



Elk County ARA Information

President	Joe Lewis N3UGB
Vice President	Jerry Robinson N3RYG
Secretary	Mary Lewis N3UDN
Treasurer	Pete Carr WW3O
Officers	Public info: Shari Lewis KB3EWT Newsletter: Jerry Robinson N3RYG Public Service: John Frantz K3TMD
Repeaters	N3NIA 147.000+ [173.8] Bootjack N3NWL 147.285+ Ridgway N3RZL 442.200+ Ridgway N3RZL 442.350+ Boone Mtn WA8RZR 443.675+ St Marys N3FYD 146.805- Emporium WA3WPS 147.180+ Emporium
Nets	Sunday @ 2000 147.000+ [173.8]
Web	www.n3nia.com

N3NIA Repeater Work



ON SEPTEMBER 6th, Fred Lenze, John K3TMD and I took down the old yagis from the top of the pole at the radio site. It was great WX with a cloudless sky and light breezes.

Each of the yagis was removed along with half the horizontal support boom. They weighed about 70 pounds each and the guys lowered them down gently with no damage to the guy wires or the fence.

While at the top I inspected the cables and grounding. Everything looked good. I did notice that the set screws that held the yagis on azimuth were severely rusted.

This allowed the whole array to swing in the wind. It was resting up against the 2-meter antenna support mast and may have been generating noise in the repeater because of that. I removed all the metal I could and made sure that the repeater antenna is mechanically secure and properly grounded.

I would like to thank Fred Lenze for bringing the small truck up for us to use. It made safe work out of a tough situation. I'd also like to thank John K3TMD for coming out to help on very short notice. Fred called to say he was available about 8 AM so I didn't

Meeting Notice

THE JANUARY ECARA club meeting is Sunday, January 18, 2013. Meetings in odd months are in the Knights of Columbus Hall in St Marys, and even months in the Elk County Courthouse annex building, 300 Center St. in Ridgway.



Listen for info on the nets or contact an officer to be sure where the next meeting will be held.

Member Activities

by Pete Carr, WW3O



John Frantz K3TMD as Net Control for the August 19th RACES net on 3.990.5 MHz. He and WW3O handled the operating duties from the Elk County Amateur Radio Association radio site on top of Boot Jack hill near Ridgway. The site is equipped with a 75 meter inverted Vee antenna and the station was run from emergency power. A total of 73 check-ins were logged.



WAYNE, NM3B of St. Marys and a member of the Elk County Amateur Radio Association has installed a satellite array. The 2-meter and 70 cm antennas are from Gulf Alpha Antennas and use fixed elevation. The rotator is a Yaesu 450. The array is fed from an Icom 910 VHF/UHF rig.

Previously Wayne had used a pair of ground plane antennas and so he was very impressed at the big signals coming from the array on such satellites as VO-52, FO-29 and AO-7. Wayne works mainly CW.

Wayne is also a member of AMSAT, The Amateur Satellite Corp.

—Pete Carr WW30



Sept. 16 Meeting Notes

by Pete Carr WW30

THE SEPTEMBER meeting of the Elk County Amateur Radio Association was held in St. Marys at the Knights of Columbus building. Elections were held to replace our President, Scott Logue N3LVG who had resigned for personal reasons. Joe Lewis N3UGB was elected to fill the remainder of Scott's term. Congratulations to Joe.

The ongoing repairs to the 147.00 repeater were discussed. It was reported that the old yagi antennas at the top of 100 foot tall cedar pole had been removed. Reception and general operation of the repeater were much improved. A list of upcoming test sessions were read to the group as well as



a report on the 5K run which the club supported at the St. Marys Airport earlier in the month. It was decided to hold the October meeting at Ridgway in the Elk County Court House and discuss future meetings in St. Marys on an alternating basis.

The meeting adjourned at 3 PM.

Submitted by Pete Carr WW30

August 19 Meeting Notes

by Pete Carr WW30

IT WAS ANNOUNCED that President Scott N3LVG has resigned the post due to family difficulties. Section II of the club constitution was read to the meeting regards the method of replacement between normal elections. Nominations were requested for consideration at the September meeting.



A discussion followed regarding the 147.00 N3NIA Motorola repeater and its repair. That is ongoing.

The topic of club meetings to be held in St Marys was brought up. Mark KB3VTY will check the K of C for a meeting room.

It was proposed that we hold a Ham-in-a-day class in Ridgway in September. Lee N3NIA will check into holding it at one of the local fire halls.

Since the old Hamtronics repeater is repaired and we have a Station Master antenna it was suggested that we place a repeater in the St. Marys area. Greg N3FYD has donated a 160 watt Mirage VHF amplifier to the club so that would work with the Hamtronics. We will look for a suitable location and then try to identify a pair of frequencies. The goal would be to provide overage down Rt-255 toward Penfield and north along Rt-120 into Emporium.

The meeting was adjourned and followed by informal discussions.

Cambria Radio Club

Serving Cambria County

to send out emails to all of the BSA troops and Elisha KB9WCX is going to work on contacting the girl scouts to get a rough estimate of the interested parties. Also Herb KB3REA is waiting to hear about the availability of the New Germany Grove Site. Herb indicated he should know by Monday if the New Germany Grove site will be available.

Horse Shoe Amateur Radio Club – Brian N3ZQY gave an update on HARC. They are still looking for a new home of the HARC. Until they find a new home, they are having a get together the first Saturday of the month at 9am. The location is the Kings restaurant at the intersection of 6th Avenue and 31st Street in Altoona. Brian also indicated they have their repeaters almost ready to be linked to WAN. They have the computers hooked up to the repeaters, and they are talking to each

Cambria Radio Club Information	
President	Chuck Englody N3LAD
Vice President	Fred Raco, Jr. N3JCV
Secretary	
Treasurer	Holli Serenko KB3PJG
Repeaters	WA3WGN 146.940- [123.0] Johnstown KC3DES 145.210- [123.0] N.Germany KC3DES 443.525+ [123.0] Carrolltwn KE3DR 146.655- [123.0] N.Cambria K3WS 147.060+ [167.9] Carrolltwn N3YFO 145.390- [123.0] Johnstown KA3ZYC 146.775- [123.0] Ebsburg
Nets	Sunday @ 2100 145.210- [123.0]
Web	cambriaradio.com

a free spaghetti dinner on Saturday October 6th, 2012 to discuss and plan the Johnstown Marathon. Dave indicated he needed operators to volunteer at the following positions.

- Control Point Operator
- Mobile Operator
- Finish Line Operator
- Shadow Operator
- Rehab and Relief operator

Dave wishes to count this as an ACS exercise. Interested operators can contact Dave at N3YFO1954@gmail.com

Jamboree on the Air (JOTA)– This seemed to be the hot topic of the night. Discussion started about JOTA before the meeting started with questions. Scott N3XCC and Elisha KB9WCX had proposed the question as to weather the girl scouts can participate in the event. They have two daughters that are involved in the girl scouts and were inquiring as to weather their troops can participate. Herb KB3REA with out hesitation answered yes, the girl scouts are more than welcome to participate.

The location of JOTA was discussed in length. 1) The New Germany Grove site was suggested by members and in the meeting agenda. The question was proposed of the weather permitting for this time of year. Herb KB3REA indicates that the scouts could use the interior building to keep out of the weather. 2) Scott N3XCC also suggested holding JOTA at the UPJ campus and/or getting the Wildcat Amateur radio club involved in JOTA. 3) Fred N3JCV also volunteered his house to host the event, however indicating his garage could hold approximately 30 individuals.

Decisions have been put on hold till early the following week. Herb KB3REA is going

Meeting Notice

THE CRC JANUARY 11TH meeting will be held at 7pm with a FREE VE Test Session at 6 pm. The location is Mount Calvary Lutheran Church 1000 Scalp Ave. Johnstown, PA.

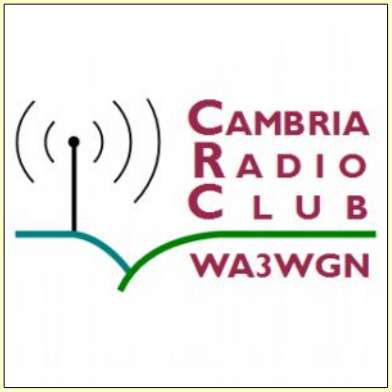

Please use the rear entrance.

A free VE Exam session will be held at 6 pm before the meeting. Exams will be given for all license classes, coordinated by Laurel VEC.

Meeting Notes

THE CAMBRIA RADIO CLUB September meeting was held Friday, November 21, 2012, Hosted by John AB3OV.

We had 14 people attend the meeting on Friday Night, including KB3REA, N3SSD, AB3OV, KB3YXR, N3XCC, KB9WCX, KE3UC, N3YFO, KA3SZD, N3JCV, N3ZQY, W3IW, Ben Sakmar, Rose Kolesar.

As members started showing up, discussions started on many different topics. The meeting started at approximately 6:15 pm.

Dave N3YFO started out the meeting by discussing the Johnstown Marathon. The date is Sunday October 7th, 2012. There is

other. However, the node list they have in the machines is incorrect. Once they get the computers set correctly, they will be WAN linkable.

John AB3OV indicated that with his new work schedule, he will no longer be able to run the Wednesday night net. Mike N3SSD offered to help out as much as he can. Thank you Mike!

CRC CARES – John AB3OV announced the launch of CRC CARES (Cambria Radio Club – Cambria Area Radio Emergency Services). John also announced his withdrawal from the ARES leadership position. CRC CARES objective is to follow closer with ACS, but still stay involved with the other groups such as ARES, RACES, and Skywarn. But the participation of other groups will depend on what members bring to CARES. Mike N3SSD will still maintain the Skywarn group participation; however the question was brought up that ARES needed a new EC and AEC, but no members stepped showed interest at that time in ARES. Anyone interested in EC or AEC for ARES is to contact Larry AB3ER at AB3ER@Yahoo.com.

Dave N3YFO discussed how ACS works and some stories of what he has done in ACS. To give an example of the importance of communications, Dave held a “Table top exercise” at the meeting which caught the attention of everyone very quickly. Dave set the scenario of damage at a repeater tower. In his example, he sends an amateur radio operator to the site with a box of ham radio gear, including a radio, antenna, computer and more. He asked that the operator take a picture and send it to him assessing the damage to the tower and asked what we would do. The answer ultimately being, all you have to do is

simply take a picture with your cell phone and send it to him. The point he was making, that even though amateur radio operators are with out a question the most qualified in communications, that the goal in ACS is effectively sending a message from point A to point B.

The meeting ended at 7:15pm with everyone anxious to move social time to the Phoenix for dinner.

August Meeting Notes

by Tom Brew K3WS

August 17, 2012

Most people in attendance started to arrive about 4:45pm as there was a FREE VE Test Session at 5:00pm. The meeting was called to order at 6:00pm by Tom K3WS who opened with “WOW One full year as Cambria Radio Club, THANK YOU!!” Thank you to everyone for attending this celebration and thank you to John W3IW who ran last months meeting and supported the NBEMS training session.

We are now 49 members strong of which 12 members are active VE’s on the Cambria Radio Club FREE VE Team.

The last group of people attending the meeting departed the about 9:45pm...

As part of our celebration we enjoyed a potluck covered dish meal and gave away 4 dual band HT’s to 4 lucky winners of our celebration door prize drawing. Each person signing the meeting sign in sheet was eligible to receive one ticket. “one chance per person club member or not” We also had a small number of Field Day 2012 T-Shirts remaining. Thank you one more time to Dave WB3JSW for the design and Emma N3VRN for coordinating the printing

of the shirts.

Introductions of guest speakers by K3WS.

Brian N3ZQY – Horseshoe ARC

Brian informed us that the HARC is still looking for a new meeting place and their club picnic is this Sunday at Highland Park. He also mentioned Tom W3SF is still working on their repeater linking project.

Dave N3YFO ACS Update

Dave gave a great update on the status and purpose of ACS and a complete report will be published in the near future. Dave is responsible for all of the WPA counties in our region and formal multimode communications between them is critical.

Dave is also seeking communication services and support for the Johnstown Marathon this year. He is looking for a few Amateur Radio operators to help out with communications during the event. The marathon will be held on Sunday October 7th, 2012 in Johnstown. The race starts at 9am and will last throughout the day. If interested, or for more information, e-mail ARES@Cambriaradio.com. There is a free dinner before the event.

Scott N3XCC – CRC VE Update

Scott as the Cambria Radio Club FREE VE Test Session Leader informed us that we have graduated 34 (new or upgraded) hams through the program to date since December 2011.

Scott also mentioned the Somerset club is looking for a new meeting place as they recently lost their long time meeting location. Suggestions are welcomed.

Congratulations to Fred N3JCV upgraded to Extra August 17th and now can work his

dream DX!! Fred is very serious about this hobby as you can see looking at his shack seen at qrz.com/n3jcv

Thank you to Scott N3XCC, Barb N3VXR, John AB3OV, and Richard W3SYY for your service at the august 17th Cambria Radio Club FREE VE Test Session.

A complete list of the VE successes can be found on the club web site VE Test Session Tab. You are able to sign up for testing on that page as well.

Jack Brew has reported that, 25 people were in attendance at the August 17th Celebration meeting including Fred N3JCV, Jack Brew, Tom K3WS, Lea Brew, Holli KB3PJK, John AB3OV, Barb N3VXR, Richard W3SYY, Ronald KB3YOJ, Mike N3SSD, Elisha KB9WCX, Scott N3XCC, Herb KB3REA, Allen KB3YVJ, Brian N3ZQY, Harry N3VRO, Dave N3YFO, Paul KB3YXS, Dave WB3JSW, Dick KA3SZD, Chuck N3LAD, Jimma Raco, Leann KB3WUD, Jim WA3ILW, and Mitch KB3JOM.

The potluck meal provided by the attending members was GREAT!!! Several home made dishes were provided including a fresh baked turkey. I can tell you it must have been good as the to-go boxes were used to take home leftovers.

Raffle winners

Names pulled by Jimma Raco...

Dick	KA3SZD	Dual Band HT
Mitch	KB3JOM	Dual Band HT
Dave	WB3JSW	Dual Band HT
Barb	KA3VXR	Dual Band HT
Leann	KB3WUD	Yaesu World Map
Paul	KB3YXS	Yaesu World Map
Jimma	N3JCV(xyl)	Yaesu World Map
Jim	WA3ILW	Yaesu World Map

Harry McGunigal N3VRO signed up as an Executive Member of Cambria Radio Club.

News from ARES EC John AB3OV

We now have a Text Message/Email alert system set up. Visit the Emergency Services Page at <http://www.CambriaRadio.com> to sign up for this important ARES notification service. Everyone is welcome to join our new alert system.

The 2011 S.E.T Results are in... (from July QST): Cambria Co. #1 Western PA Activity and Cambria Co. #1 Local Net thanks to Ray KB3WDN. We are looking for volunteers for 2012 SET. Western PA made the top 10 in both areas. Way to go WPA ARES TEAM... The link to the QST article can be found on the club website. NEW!!!! For all current Cambria County ARES Activity please visit our Cambria County ARES Facebook page. Please post your comments and questions and "like" all you want. \ <http://www.facebook.com/CambriaCountyAres>

A year in review: "The Big Stuff"

It's a CELEBRATION Wow one year really???

Aside from countless new or renewed relationships that have been formed, sponsors coming forward to help grow the club and support the events, and just good old radio operations we pulled off some big events that deserve a place on the year in review time line. Please realize without the help of each and every one of you this would not have been possible!!!

In the first few months... The new Cambria Radio Club is formed and at the same time The Wide Area Network Repeater System takes off like a rocket. More hams are using local repeaters and the RF is flying all over

the area. Local and regional nets are back on the air including digital operations. The first CRC meeting kicks off using linked repeaters as the technology theme hosted by Brian KB3ORS, Systems Administrator for WAN-RS. Every meeting thereafter hosted a theme of interest. By the time of our first Christmas party we were providing FREE VE Testing and planning our first major club sponsored event... We saw meeting attendance grow which includes members from over 4 counties and today includes an out of state active member. Corporate sponsorship and private donations began to come in affording us the ability to host projects and properly support the .940 and .775 repeaters.

A new club house (Mount Calvary Lutheran Church) is found by Herb KB3REA and Wireless Internet Installed by Scott N3XCC, Elaine K3EMM, and Kevin WJ8G.

CRC FREE VE Testing is established by Scott N3XCC and The Laurel Amateur Radio Club VEC. To date we have helped to create or upgrade 34 amateur radio operators. We offer FREE VE Testing at almost every other club meeting and every special event. Our sessions are open to everyone who can make it to a session. We are looking into ways of helping individuals with various challenges to attend the FREE Test Sessions.

UPJ FREE VE Test Session The CRC VE Test team was called to perform the UPJ Amateur Radio Testing for the UPJ Engineering Class. Passing an amateur radio exam is a requirement of the class lead by Professor William Wiserman K3ZYK. VE Team Members Barb KA3VXR and Dan KE3UC have served on the past VE Team testing UPJ students and now serve on the CRC FREE VE Team. A photograph of the

past was shared showing Dan and Barb in almost the same spot while it was rumored Dan was even wearing the same shirt...

Thank you for testing the students and walk-ins that attended the FREE Test session. This is an event we hope to do again and we plan to join forces with the IEEE UPJ Mountain Cat Amateur Radio Club for future events and training.

Merit Badge in a Day and a Ham to Stay was planned, coordinated, and lead by Herb KB3REA. Talk about and experienced master of ceremonies! This was a multi day event with just over 300 attendees, resulting in 150+ Boy Scouts earning their radio merit badge and 40+ amateur operators participating in radio operations and training presentations. Including a very special visit and demonstration by Detachment 1, 586 Engineer Company US Army National Guard who spent their Saturday Demonstrating the Stryker Vehicle and man pack communications systems. With the support of the great individual and corporate sponsors we were able to perform this entire event including the facility, food, and course materials FREE to the Boy Scouts saving them approximately \$4,000.00. This may become an every other year event.

Club Member answers a call for community service: May 2012... Still Using Crystal Radio by: Barbara Zaborowski, Ph.D. and Mike N3SSD: Middle School Reading Program works Crystal Radio with the help of a Cambria Radio Club Member. The One Book, One Community Middle School Reading Program was started in 2006 and involves students from all the public and private schools in Cambria County. This year's theme was the Great Depression. Students all read the book, "Macaroni Boy" by Pittsburgh author

Katherine Ayres. As part of the three-day event, students come to the College to meet the author and take part in hands-on demonstrations. One of those demonstrations involved making a crystal radio. Without Mike's (N3SSD) help, we would never have been able to demonstrate the crystal radios to the students. Thanks, Barbara Zaborowski, Ph.D. Full story on Events page at the club website.

Digital operations become a big training effort hosted by Dave WB3JSW and supported by Dave N3YFO. Dave WB3JSW took on the task of starting the Wednesday Night Digital Training Net that helped many operators learn and use the many modes of digital operations. Dave N3YFO went on to run the Digital Information Net. Digital operations have become a big part of CRC.

Multi Club Field Day 2012 Wow!!! Where do we start? The Cambria Radio Club and the Horseshoe Amateur Radio Club joined forces and tested emergency communications June 22nd - June 24th, 2012. With Ham's, their RV's, and Tents arriving as early at 2pm Friday, the event was open to the public at with a free Hot Dog lunch from Noon - 1pm Saturday, and a fireworks show Saturday night. Mike, Cambria Radio Club Member N3SSD, was the Lead Fireworks Shooter. Barb KA3VXR and Emma N3VRN and their helpers truly did a great job in their NEW field day kitchen at the New Germany Grove Hall feeding everyone. Dave WB3JSW designed a nice field day logo used on the K3F QSL card and the special field day T Shirt. Chris KA3JIB is now a local TV star covering field day with Fox8 News as our face of Field Day...

We received very nice media coverage from The Tribune Democrat and FOX8

Television News. In addition to the general public and the Summerhill Fire Department, 33+ Amateur radio operators and 17 family members representing 5 ARC's were in attendance for this event of food, fun, radio operations, camping, and fellowship. The Field Day event included a FREE VE Test Session and an almost endless bonfire thanks to Fred N3JCV and Jack Brew. We look forward to Multi-Club Field Day 2013 at The New Germany Grove hall. Come join us...

NBEMS Training by John W3IW Harry, W3YJ, really did a great job of introducing the NBEMS software to the club and visitors. Many had already begun using NBEMS based on the excellent training that Dave, WB3JSW, provided this past spring. We started at 3:00 PM and ended at 5:30. Very comprehensive training as only Harry presents. We look forward to the advanced digital training in the future and the use of digital operations in our future nets.

In Closing by K3WS Like I said before NONE of this would have been possible without the support and participation of each and every club member and our sponsors. Your contributions of money, time, experience, and talent are the foundation of our joint success. Our club is based on donations and membership levels exist at every level of support.

Each active member will be issued a Cambria Radio Club Identification Badge that will be created by Herb KB3REA. I do not plan to remind everyone to donate yearly for membership as I trust in the belief we are all adults and will do what we can and when we can to support the club and our future projects. There are many ways to donate as many of you already know.

I said a year ago there will be changes and

a lot of them but all changes and decisions will be made in the best interest of our group and the betterment of the amateur radio hobby for our area. We will do as much as we can to help the community and create new amateur radio operators and further develop our operating skills.

Going into the next year John AB3OV will help complete the formation of the Cambria County ARES and SkyWarn programs as our new ARES EC and with the help of his team we will become an effective communications resource in the time of need.

May God bless each and every one of you! Thank you in advance for your support and participation in the next year with the Cambria Radio Club.

Most if not all of our stories can be found on line at <http://www.parasiticemission.com/2012/> . Thank you Joe W3BC for this valuable resource, your service in this great hobby, and creating our club logo a year ago. Best wishes in the coming year.

Respectfully,
Tom Brew K3WS, President and Trustee

CRC Random Clips

While .390 and .210 are not at full capacity .940 is wanrs.com connected full time.

As always feel free to bring equipment or projects to discuss in the meeting. Maybe someone can even help you solve a problem.

Cambria Radio Club is now on Facebook. Everyone is welcome to post... Link on CRC site.



2013 Club Connections

Announcement

by Tom Brew K3WS

Attention all Cambria Radio Club Members:

I am excited to announce that Charles Englody (Chuck) N3LAD has accepted the position, President of Cambria Radio Club. This, pending club officer elections in February 2013. Chuck has experience in many areas that will complement him in this role. Tom Brew will remain Trustee of WA3WGN and a VE for Scott N3XCC and the Cambria Radio Club Free VE Team.

I am going through some personal and health related issues that make it impossible for me to efficiently serve as an active club president. Chuck and the club will continue to have my support and guidance as my time allows now and in the unlimited future.

The current CRC web site membership page is being updated to reflect the year your membership donation covers as mentioned on your application. We do not send out membership / donation reminders as we only expect what you can afford when you can afford it. **Thank God for our corporate sponsorship to date.**

The US Mail address has been updated for the CRC on the on-line membership application. All new membership applications and donations should be sent to the new address seen below. Pay-Pal donations may be sent to wa3wgn@gmail.com

New Address:

NEW US MAIL ADDRESS for all CRC business and membership snail mail
Cambria Radio Club

196 Barron Avenue
Johnstown, PA 15906
Phone: 814 341-6102
paypal donations wa3wgn@gmail.com

Regular Club Meeting Address:
Cambria Radio Club - Shack
Mount Calvary Lutheran Church
1000 Scalp Avenue
Johnstown, PA 15904

Reassurance:

You all have stepped up and proven several times over you are a unified group capable of great things as witnessed in the past year. It was each of you that made each club sponsored event a success, not me. I may have simply had an idea but you all did the work and made it happen...

Transition:

Chuck will assume his new role effective October 1, 2012. Chuck's contact information is N3LAD@CambriaRadio.com, phone [\(814\) 341-6102](tel:8143416102)

I have sent Chuck a CRC check for \$1,248.00 which represents the current checking account balance. Chuck will establish a new CRC account as the account I had setup was not good and was going to start charging fees.

I will send Chuck the club expense records and access to the officers section of the CRC DropBox containing additional club related files and records.

The web domain CambriaRadio.com and the WA3WGN@gamil.com accounts are owned by CRC and Chuck will become trustee of them as well. **Unlike what often happens to club websites, we will not need to scramble for a new website or email account. I made sure of that from the start.**

I will give guidance and support as requested to assist Chuck in the transition.

The meeting schedule is set for the rest of 2012 as seen at CambriaRadio.com

Trustee

As mentioned and as protection of 146.940 and WA3WGN I will remain the Trustee until a time in the future I feel comfortable assigning Trusteeship to the next Trustee, however I will assign N3XCC as backup trustee. Scott as you all know has more than proven his commitment to Cambria Radio Club, the club repeaters, other local repeaters, The Wide Area Network Repeater System, creating new hams as a VE Team Leader, and the community. I made a promise to keep 940 in Johnstown and I intend to keep that promise.

Closing

Thank you very much to each of you for your support during my term as Cambria Radio Club President and please give Chuck the same level of support you gave me and your fellow members.

Please remember it was each of you that made the past year what it was.

I will keep you all posted from time to time as I have my own news to report. I do plan to remain active in WAN and supporting repeater coverage as time permits.

Respectfully,

Tom Brew - K3WS



600 Meter Bandpass Filter

by Michael Sapp WA3TTS

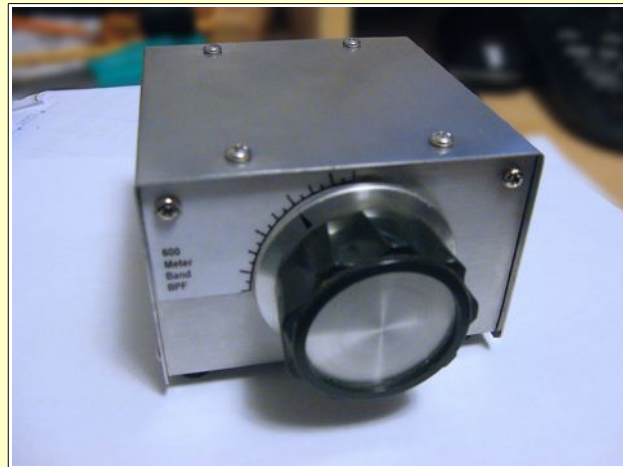

I HAVE BEEN listening to hams transmitting with experimental stations in what is soon to become the new 600 meter amateur band, at frequencies around 490 kilohertz. I built this bandpass filter to help reduce the interference from strong, local broadcast stations.

This 600M Bandpass Filter was scaled down approximately 5% in frequency from the original W1VD BPF design at 505 ~ 515 kHz to cover the 475 to 505 kHz range with a similar bandpass response.

Primary component changes involved increasing the original W1VD design inductor values from 139uH up to 149 uh, using an affordable VICHY DM4070 LCR Meter (commonly sold on eBay) for inductance measurements. The scaled 149uh inductor v simply took an additional 2 turns of wire on a T-61-50 ferrite from the original W1VD design 45 turn, 139 uh, inductor—47 turns total—but measured with the LCR meter for closely matching all three inductors to the 149uh range.

Care was taken to measure every L and C component used in the filter, including the 3-gang capacitor. This variable capacitor was a junkbox unit missing it's trimmer capacitors. The front section measured 351pf, the center section 360pf and the rear section 356 pf.

Instead of the 20pf trimmer capacitors used in the original W1VD design, a set of 9-35 pf ceramic capacitors were used out of some surplus equipment boards. The W1VD filter build information suggests using 50 pf trimmers for more tuning adjustment flexibility, but the 9-35 pf trimmers turned out to be adequate for the task.

All fixed value capacitors in the filter are high-quality, 5% tolerance, polystyrene types, purchased from www.justradios.com.

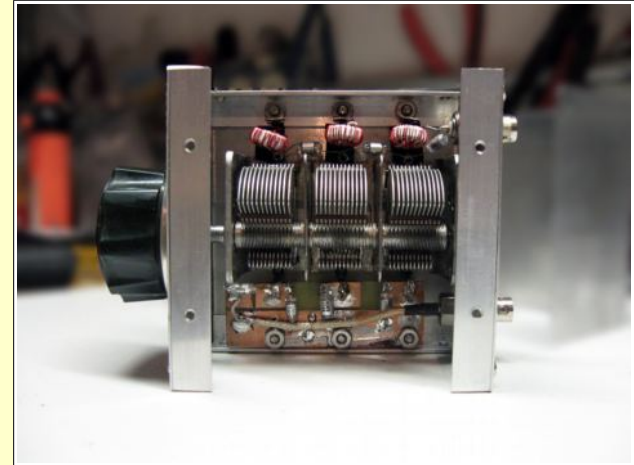

The 360pf center section fixed capacitor was not available in the specified value, but a polystyrene 350pf value was available and used in this filter. No other fixed capacitors were adjusted 5 percent higher in value, as the change amounted to the fixed capacitor value tolerance limits. Between the slightly higher capacitance in the center section of the 3-gang variable capacitor and the use of 9-35 pf trimmer capacitors, there was adequate capacitance available to meet the 360pf value requirement in the center section of the filter circuit.

A small, double-sided printed circuit board was used to mount the trimmer capacitors and some of the fixed capacitors. This board was mounted on standoffs and well grounded to allow installing the trimmer capacitors on the underside and the fixed capacitors on the top side of the circuit board. This electromechanical arrangement offers a rigid mounting method to provide access to the trimmer capacitor adjustments from through-holes in the bottom of the unit enclosure. It also is intended to minimize any mechanical vibration and thereby maintain the filter alignment over the long term. No additional adjustments should be necessary in normal use of the filter.

One of the 50 ohm BNC connectors was

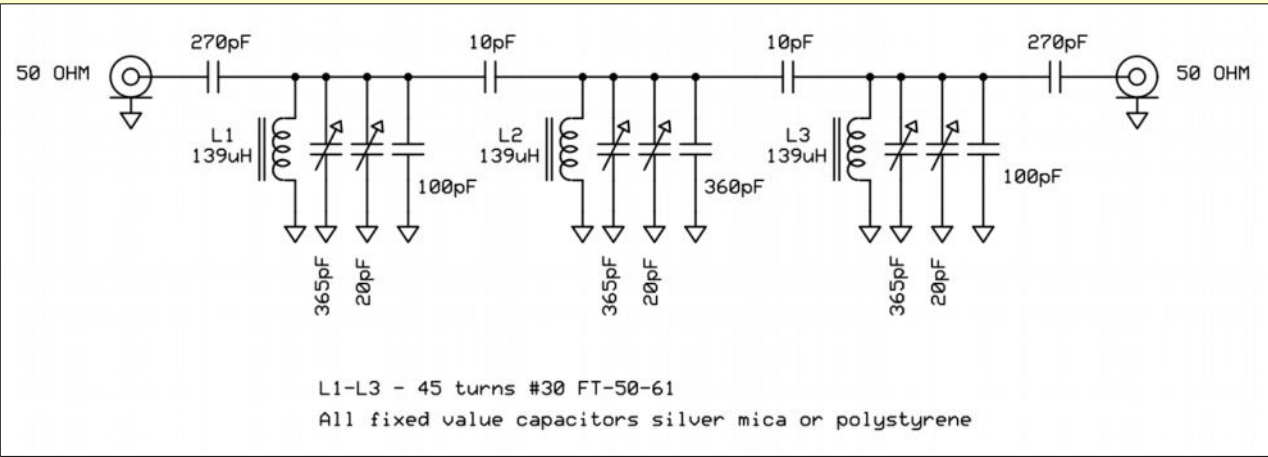

Tune in the excitement at 475 kHz, soon to be the newest ham band

selected as a shielded bulkhead type with double shielded mini-coax to minimize stray coupling with the other BNC connector port and other filter components.

An oversize tuning knob was selected to make tuning adjustments easier. Tuning is particularly sharp at 475 kHz and a small knob was deemed difficult to adjust during the initial filter testing phase of the project. The tuning scale was laser-printed from a PC and clear packing tape used as a protective laminate. 3M Contact Adhesive was used to secure the labels. A Dry Erase marker can be used to mark temporary tuning points as small dots on the tuning scale. Those marker points can then be easily removed with a damp cloth.

The filter cabinet was constructed from two pieces of 6 x 18 x .025" aluminum panel stock and 1/2" aluminum angle stock, available at home centers (Lowe's, Home Depot, etc.) The angle stock provides rigidity to the cabinet and was tapped for 6-32 fasteners. All fasteners are stainless steel. In hindsight, a die cast box would have likely been a cheaper alternative. The panel stock is relatively soft aluminum alloy and scratches easily. A plastic fiber autobody scrubby pad can be used to rub out minor scratches on the aluminum enclosure.

For filter installation, it is suggested to use double-shielded 50 ohm BNC jumper cables, as the filter selectivity is high enough to exceed the performance range of average quality, single-shield, cables.

If a **high-dynamic range** 2N5109 preamplifier is available (W1VD, Clifton Labs, etc.), it would be advantageous to place the preamplifier between the filter and the antenna, especially for operation at 475 kHz range where the insertion loss was measured at 5.7dB on an Agilent 8753ES Net-

work Analyzer. At 495 to 505 kHz, the insertion loss of the filter is approximately 2dB. In this frequency range, there is approximately 3dB less attenuation of BCB stations, but enough AM broadcast attenuation should be available to still allow preamplifier placement ahead of the filter.

One of the local TV station engineers was kind enough to provide access to his station's Agilent 8753ES Network Analyzer for the plot information shown below. Note that my initial filter response measurements and filter tune-up were made with a Wavetek 132, 0~2 MHz, signal generator and a Boonton CA91 RF Voltmeter---both of which were obtained on ebay for less than a \$100 combined investment. These surplus-grade test instruments allowed for bandpass filter skirt response testing down 50dB with a 1~3 dB of variability. No re-adjustment of the filter was attempted when it was on the network analyzer, as the surplus test equipment used in initial testing was more than sufficient for filter alignment.

Frequency Response Plots

These plots were made from 300 to 1800 kHz, representing 150 kHz per X-axis divi-

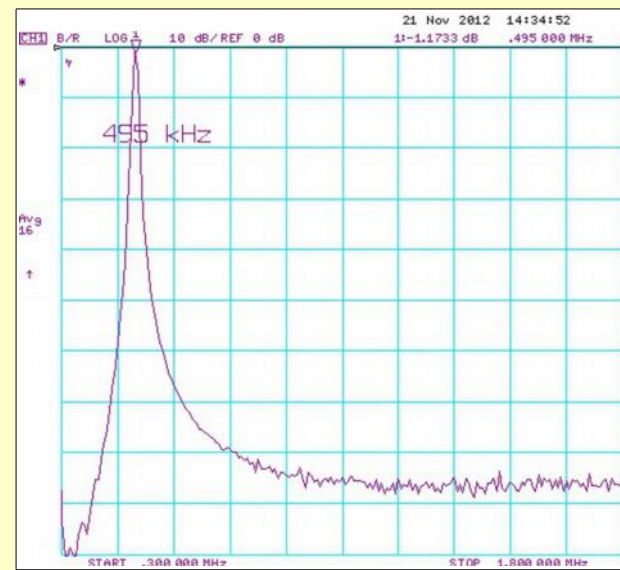

sion and a Y-axis of 10 dB per division.

Return Loss Plots

These plots show frequency from 300 to 1800 kHz in 150 kHz per division in the X-axis and reflected power in dB in the Y-axis at 10dB per division. Return Loss is shown for 475 and 495 kHz tuning dial positions. For those unfamiliar with Return Loss measurements, a 10dB Return Loss value represents 10 percent reflected power and a 20 dB measurement represents a 1 percent reflected power level.

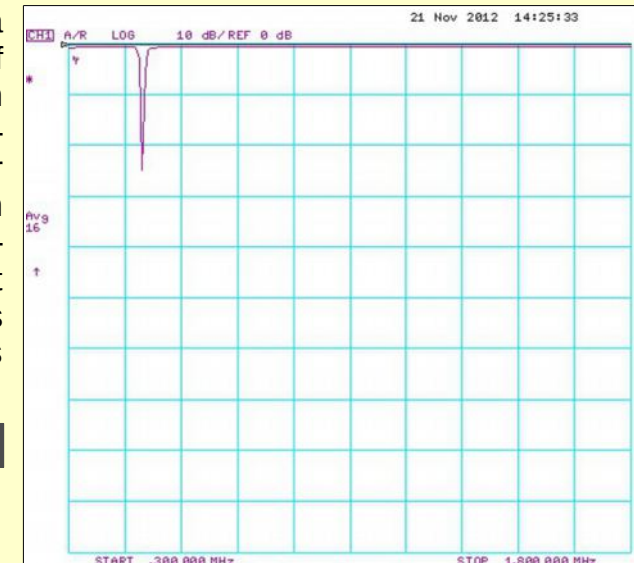

On-Air Tests

Initial on-air testing demonstrated that almost all AM broadcast stations could be just about completely attenuated with the filter tuning adjusted to the 600M band range. [This YouTube™ link](#) demonstrates how the filter performs in the lower portion of the AM broadcast band where the bandpass response is much wider than in the 600M band. A few evenings of WSPR monitoring of WF2XXQ on 495.9 kHz near Miami, FL with the filter yielded consistent decodes in the -20 to -33 SNR range. Most

A local TV station engineer provided access to an Agilent 8753ES Network Analyzer

of the decodes were in the -25 to -30 range. My location is near Pittsburgh PA, using a modest EWE antenna and FT-847 transceiver with no external preamplifier in the 600M band. It is noted that even with the filter in use and nearly all BCB energy absorbed by the filter, I still had a few carriers on the WSPR waterfall display—likely local interference from consumer digital devices in my neighborhood.



A special thank you to W1VD for making his impressive 500~515 kHz BPF filter design information available on his w1vd.com web site. It was a worthwhile technical project to experiment with linearly scaling the W1VD filter L and C components to a nearby frequency range and observing the resulting filter performance with the improvements of using of a shielded 3-section variable capacitor and high-quality polystyrene fixed capacitors. I am also satisfied with my modest investment in the surplus Wavetek signal generator and Boonton CA91 RF Voltmeter—eBay "finds" that were used for initial filter testing and tune-up in this project.

Letters

From Our Readers

Just as an FYI, whenever I get one of the new PE PDFs I always forward it to my Dad in Maryland (he grew up in Du Bois) as he likes it.

He's been sending it to guys down there and one of them sent this reply to him today:

"Thanks! They produce probably the best newsletter I have ever seen. Someone is really putting in an effort."

Just wanted to let you know others appreciate your hard work as well.

Marc

W3MDJ

Shorts

From The Headwaters ARC...

Hello All,

Anyone interested in seeing a tour inside the international Space Station check this out. **[Best 45 minutes you will ever spend! - Ed.]**

<http://www.wimp.com/orbitaltour/>

Straight Key Night

ATTENTION CW operators: Don't forget that New Year's Eve and New Year's Dy are the annual "Straight Key Night."

Fire up that old brass pump handle, and enjoy a good QSO or two on any CW band. It's not a contest, it's a chance to do some real old-school hamming!



Pete Carr WW30 and Wayne Ginther NM3B exchange QSL cards. Their QSO was on the VO-52 satellite using single sideband. Wayne is trying to work all states on satellite and needed Pennsylvania. The picture was taken and the November Elk County Amateur Radio Association meeting.

The Hamshack Net

The Hamshack Net is a friendly ragchew net that meets every Wednesday evening at 7:00 pm. Starting in January, we will be testing the use of the WAN Repeater System, to see if more hams can make it even more fun!

Here is January's proposed list of topics:

Jan 2: What ham radio resolutions (or goals) do you have for this year?

Jan 9: What club activities are well received by new and inactive hams?

Jan 16: Getting started with do-it-yourself radio projects

Jan 23: If a friend asks you about ham radio, how do you show him what it's all about?

Jan 30: How can we help inactive old-timers get re-interested in ham radio?

Let's spread the word and see what happens...

Probably the best newsletter I have ever seen.

The Parasitic Emission

January 2013

Amateur Radio Club Activities, Events and Gatherings

Sunday	Monday	Tuesday	Wednesday	Thursday	Friday	Saturday
30 7:00pm» QCARC 2-meter FM Net 7:30pm» Clearfield County A.R.E.S. Net 8:00pm» Elk Co ARA Net 9:00pm» WAN ARES Net	31 Parasitic Emission Publication 7:00pm» ARRL Straight Key Night 7:00pm» HARC Nets 7:30pm» Punxsutawney ARC 2 Meter Net 8:00pm» Jefferson County EMA Radio Service Net	01 12:00am» ARRL Straight Key Night (cont.) New Year's Day 7:30pm» Indiana Co ARC Meeting	02 7:00pm» Hamshack Net 9:00pm» Cambria County ARES Net	03 7:00pm» Headwaters ARC Meeting	04	05
06 7:00pm» QCARC 2-meter FM Net 7:30pm» Clearfield County A.R.E.S. Net 8:00pm» Elk Co ARA Net 9:00pm» WAN ARES Net	07 7:00pm» HARC Nets 7:30pm» Punxsutawney ARC 2 Meter Net 8:00pm» Jefferson County EMA Radio Service Net	08 7:00pm» Punxsutawney Area ARC Meeting	09 7:00pm» Hamshack Net 9:00pm» Cambria County ARES Net	10	11 6:00pm» CRC Free VE Exam 7:00pm» Cambria Radio Club Meeting	12 9:30am» Quad-County ARC Breakfast 10:00am» Potter Co. ARES VE Exam Session
13 7:00pm» QCARC 2-meter FM Net 7:30pm» Clearfield County A.R.E.S. Net 8:00pm» Elk Co ARA Net 9:00pm» WAN ARES Net	14 7:00pm» HARC Nets 7:30pm» Punxsutawney ARC 2 Meter Net 8:00pm» Jefferson County EMA Radio Service Net	15	16 7:00pm» Hamshack Net 9:00pm» Cambria County ARES Net	17	18 7:30pm» Quad-County ARC Meeting	19
20 1:30pm» Elk County ARA Meeting 7:00pm» QCARC 2-meter FM Net 7:30pm» Clearfield County A.R.E.S. Net 8:00pm» Elk Co ARA Net 9:00pm» WAN ARES Net	21 Martin Luther King's Birthday 7:00pm» HARC Nets 7:30pm» Punxsutawney ARC 2 Meter Net 8:00pm» Jefferson County EMA Radio Service Net	22	23 7:00pm» Hamshack Net 9:00pm» Cambria County ARES Net	24	25	26
27 7:00pm» QCARC 2-meter FM Net 7:30pm» Clearfield County A.R.E.S. Net 8:00pm» Elk Co ARA Net 9:00pm» WAN ARES Net	28 Parasitic Emission Submission Deadline 7:00pm» HARC Nets 7:30pm» Punxsutawney ARC 2 Meter Net 8:00pm» Jefferson County EMA Radio Service Net	29	30 7:00pm» Hamshack Net 9:00pm» Cambria County ARES Net	31	01	02 Groundhog Day Event

February 2013 Calendar

Amateur Radio Club Activities, Events and Gatherings

Sunday	Monday	Tuesday	Wednesday	Thursday	Friday	Saturday
27 📻 7:00pm» QCARC 2-meter FM Net 📻 7:30pm» Clearfield County A.R.E.S. Net 📻 8:00pm» Elk Co ARA Net 📻 9:00pm» WAN ARES Net	28 📻 Parasitic Emission Submission Deadline 📻 7:00pm» HARC Nets 📻 7:30pm» Punxsutawney ARC 2 Meter Net 📻 8:00pm» Jefferson County EMA Radio Service Net	29	30 📻 7:00pm» Hamshack Net 📻 9:00pm» Cambria County ARES Net	31	01	02 📻 Groundhog Day Event
03 📻 7:00pm» QCARC 2-meter FM Net 📻 7:30pm» Clearfield County A.R.E.S. Net 📻 8:00pm» Elk Co ARA Net 📻 9:00pm» WAN ARES Net	04 📻 7:00pm» HARC Nets 📻 7:30pm» Punxsutawney ARC 2 Meter Net 📻 8:00pm» Jefferson County EMA Radio Service Net	05 📻 7:30pm» Indiana Co ARC Meeting	06 📻 7:00pm» Hamshack Net 📻 9:00pm» Cambria County ARES Net	07 📻 7:00pm» Headwaters ARC Meeting	08 📻 6:00pm» Cambria Radio Club Meeting	09 📻 9:30am» Quad-County ARC Breakfast
10 📻 7:00pm» QCARC 2-meter FM Net 📻 7:30pm» Clearfield County A.R.E.S. Net 📻 8:00pm» Elk Co ARA Net 📻 9:00pm» WAN ARES Net	11 📻 7:00pm» HARC Nets 📻 7:30pm» Punxsutawney ARC 2 Meter Net 📻 8:00pm» Jefferson County EMA Radio Service Net	12 📻 7:00pm» Punxsutawney Area ARC Meeting	13 📻 7:00pm» Hamshack Net 📻 9:00pm» Cambria County ARES Net	14	15 📻 7:30pm» Quad-County ARC Meeting	16
17 📻 1:30pm» Elk County ARA Meeting 📻 7:00pm» QCARC 2-meter FM Net 📻 7:30pm» Clearfield County A.R.E.S. Net 📻 8:00pm» Elk Co ARA Net 📻 9:00pm» WAN ARES Net	18 📻 Presidents' Day 📻 7:00pm» HARC Nets 📻 7:30pm» Punxsutawney ARC 2 Meter Net 📻 8:00pm» Jefferson County EMA Radio Service Net	19	20 📻 7:00pm» Hamshack Net 📻 9:00pm» Cambria County ARES Net	21	22	23
24 📻 7:00pm» QCARC 2-meter FM Net 📻 7:30pm» Clearfield County A.R.E.S. Net 📻 8:00pm» Elk Co ARA Net 📻 9:00pm» WAN ARES Net	25 📻 Parasitic Emission Submission Deadline 📻 7:00pm» HARC Nets 📻 7:30pm» Punxsutawney ARC 2 Meter Net 📻 8:00pm» Jefferson County EMA Radio Service Net	26	27 📻 7:00pm» Hamshack Net 📻 9:00pm» Cambria County ARES Net	28	01	02